

medBike®

OPERATION MANUAL

950-192

950-194

950-193



BIODEX

Biodex Medical Systems, Inc.

20 Ramsey Road, Shirley, New York, 11967-4704, Tel: 800-224-6339 (Int'l 631-924-9000), Fax: 631-924-9338, Email: info@biodex.com, www.biodex.com

medBike



This manual covers installation and operation procedures for the following products:



















- | | |
|---------|-----------------------|
| 950-192 | medBike, Lower Body |
| 950-194 | medBike, Whole Body |
| 950-193 | medBike, Calf Support |

Table of Contents

medBike	2
Definition of Symbols.....	4
Product Certifications and Classifications.....	5
Before Proceeding.....	5
Important Safety Information	6
1. Introduction	8
General Cleaning and Maintenance	8
2. Parts and Adjustments	9
3. Set-up and Operation	10
Unpackaging and Assembly.....	10
Adjusting Pedals on the medBike	14
Positioning or Relocating the medBike	15
Display and Handlebars Height Adjustment	15
Positioning for Upper Body Exercise	16
On / Off.....	16
Settings	17
Spasm Control	18
Emergency Stop	19
4. Active Modes	21
Active Manual Mode.....	21
Active Resistance Mode (Program A)	23
Continuous Watt Mode (Program B)	25
5. Passive Modes	29
Passive Manual Mode.....	29
Passive User Profile Mode	31
Passive Pedal/Arm Crank Assisted Mode	33
6. Specifications	37

Definition of Symbols

The following symbols and their associated definitions are used and implied throughout this manual.

Symbol	Definition
	Carefully read these instructions prior to use
	Caution
	General Warning
	General Mandatory Action
	Dangerous Voltage
	“On” Power
	“Off” Power
	Earth (ground)
	Alternating Current
	Fuse
	USB Connector/Cable
	Waste in Electrical Equipment
	Date of Manufacture
	Manufactured By
	Type B Applied Part
	CE Mark
	CE Mark for products with EC Certificate
	Certified for Safety by ETL Intertek

Product Certifications and Classifications

The medBike has received the following certifications, and falls within the following classifications:

- EN: ISO 20957-1:2013.
- UL: 1647:2011/R2014-11.
- CAN/CSA-C22.2 No.68: 2009 + UPD No. 1:2010-02 + UPD No. 2: 2010 + 09.

FCC: Compliance:

- EN55014-1: 2006 / A2: 2011.
- EN55014-2: 1997 / A2: 2008.
- EN61000-3-2: 2014.
- EN61000-3-3:2013.

NOTE: *Circuit diagrams for this product are provided on the Biodex website, www.biodex.com or can be obtained by contacting Biodex Customer Service (see Contact information).*

Note: *Complete information on the Electromagnetic Compatibility for the medBike can be located in the Compliance Supplement located on the Biodex website (www.biodex.com) or can be obtained by contacting Biodex Customer Service (see Contact information).*

Before Proceeding



NOTE: *The warnings, cautions and instructions provided in this manual must be read, followed and kept available for consultation at all times. Observing the information, instructions, and procedures presented throughout this manual is essential for using this product both properly and safely.*



SPECIFIC CAUTIONS

- Allow only qualified, trained personnel to operate or service this product.
- If the equipment is used in a manner other than specified in this operation manual, the protection provided by the equipment may be impaired and results could be compromised.



CAUTION: Unauthorized modifications to this product are not permitted and will void the manufacturer's warranty. Unauthorized modification of the product may result in a hazard to the user and/or patient. Do not modify this equipment without authorization from the manufacturer.

For additional technical advice, service or education information, please contact:

Important Safety Information



Follow the assembly and installation instructions document.



Before using this device, read the entire operation manual carefully. Failure to read the manual may result in user error or inaccurate data. Be sure to save all provided documents for future reference.



Make certain to understand all warning and caution labels as explained in the Before Proceeding section of this manual.



This product should be used only as specified in the operation manual.



CAUTION: Biodex devices are designed for use in a client environment.



For product specifications, refer to the Table of Contents.



CAUTION: Operation: 115 VAC.



WARNING: Only use approved power supplies.



CAUTION: To avoid risk of electric shock, this equipment must only be connected to supply mains with protective earth.



CAUTION: The plug is considered the method of disconnecting the product from main power. Do not place the product in a position where the plug is not easily accessible.



This product is intended to remain in one location during operation. It is provided with wheels for relocation which should be used when moving.

Biodex Warranty

Refer to the warranty card included with the product or contact Biodex Support Services.



Contact information



Manufactured by:

Biodex Medical Systems, Inc.
20 Ramsey Road, Shirley, New York, 11967-4704
Tel: 800-224-6339 (Int'l 631-924-9000)
Fax: 631-924-8355
email: supportservices@biodex.com
www.biodex.com <http://www.biodex.com/>

1. Introduction

Intended Use

The medBike is designed to provide a safe, ergonomic environment for the clinician and customer. The design features are intended to relieve musculoskeletal stress while providing the utmost comfort during exercises.

Indications for Use

The medBike is typically used in cardiovascular facilities, skilled nursing facilities, elder care fitness centers, and private practice clinics to achieve quality exercise sessions for a variety of health wellness applications.

General Cleaning and Maintenance

1. As required, cleanse all exterior surfaces and seat pad with a mild detergent solution such as Parker Laboratories Protex Disinfectant or any one-step disinfectant that does not contain bleach.
2. Keep pedal/arm crank and wheel assemblies free of foreign materials and dirt accumulation.
3. Periodically inspect all welds.
4. Periodically check bolts, tighten if necessary.
5. Periodically inspect pedal/arm crank strap holders.

2. Parts and Adjustments



Figure 2.1. The Biodex medBike Parts and Adjustments

Standard Parts and Adjustments:

1. 10" display
2. Non-allergic, high-density grip
3. Telescopic handlebar post, adjustable knob
4. Full metal frame enamel powder, electrostatic spraying
5. Safety pedal with straps
6. Durable transport wheels
7. Power on/off
8. Upper body adjusting knob
9. Upper body hand crank

Optional:

10. Calf support (950-193)
11. Hand/Wrist cuff (S,M,L) (S) 950-247, (M)950-243, (L)950-234

3. Set-up and Operation

Unpackaging and Assembly

The medBike Whole Body Cycle ships and arrives fully assembled.

The medBike Lower Cycle requires a minimal amount of assembly. An Allen wrench, provided within the packaged contents, is the only tool required.



Figure 3.1. medBike – packaged contents.

Begin by removing the medBike's main pedal/arm crank/motor assembly from the packaging. Inside the tube opening, just above the knob, there is a cable that connects the display to the motor. Using the guide wire attached to the cable, move the cable up through the handlebars stem tube (Figure 3.2), place the tube into the pedal/arm crank/motor assembly opening, and affix the handlebars stem tube with a bolt using the Allen wrench (Figure 3.3).

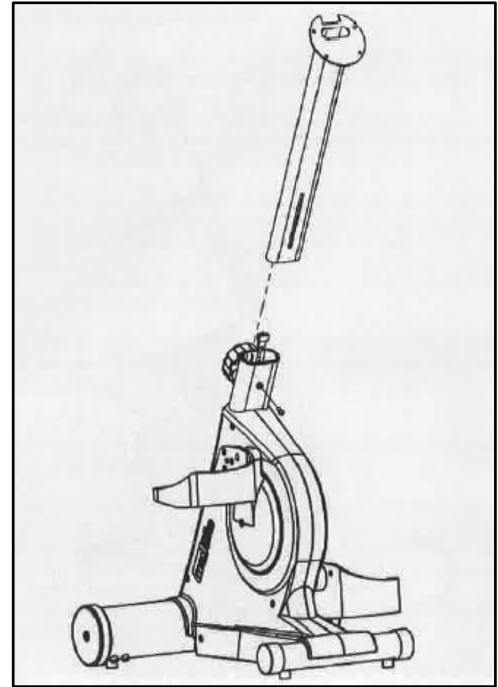

Figure 3.2. Use the guide wire to move the display cable up through the handlebars stem tube.



Figure 3.3. Use the Allen wrench to affix the handlebars stem tube to the pedal/arm crank/motor assembly.

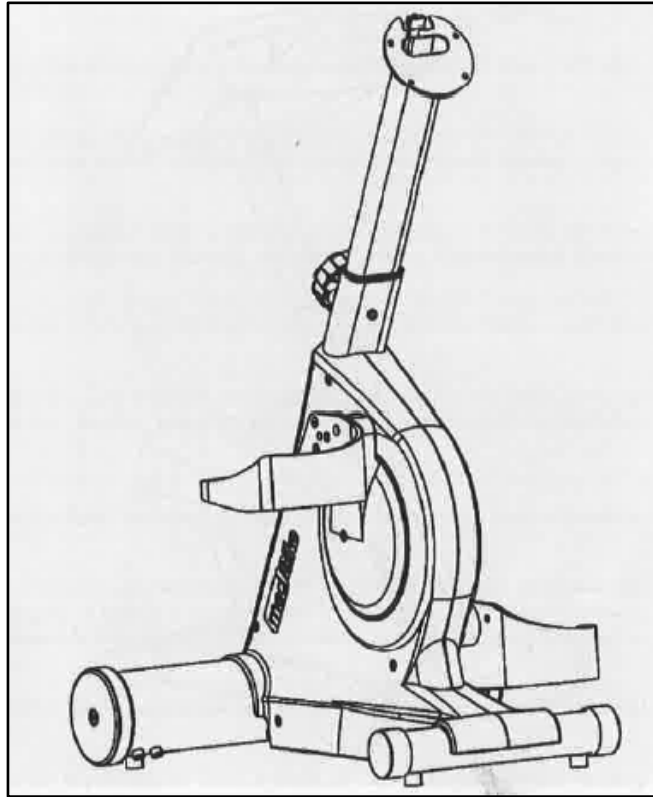

Figure 3.4. Handlebars stem tube--secured in pedal/arm crank/motor assembly.

Once the bottom of the handlebars stem tube has been secured, the display can be affixed to the top. But first, the cable must be connected as illustrated below:



Figure 3.5. Connect the display cable.

Line up the holes in the back of the display with the four holes on the top of the handlebars stem tube and affix the two pieces with the four bolts. Use the Allen wrench to tighten.

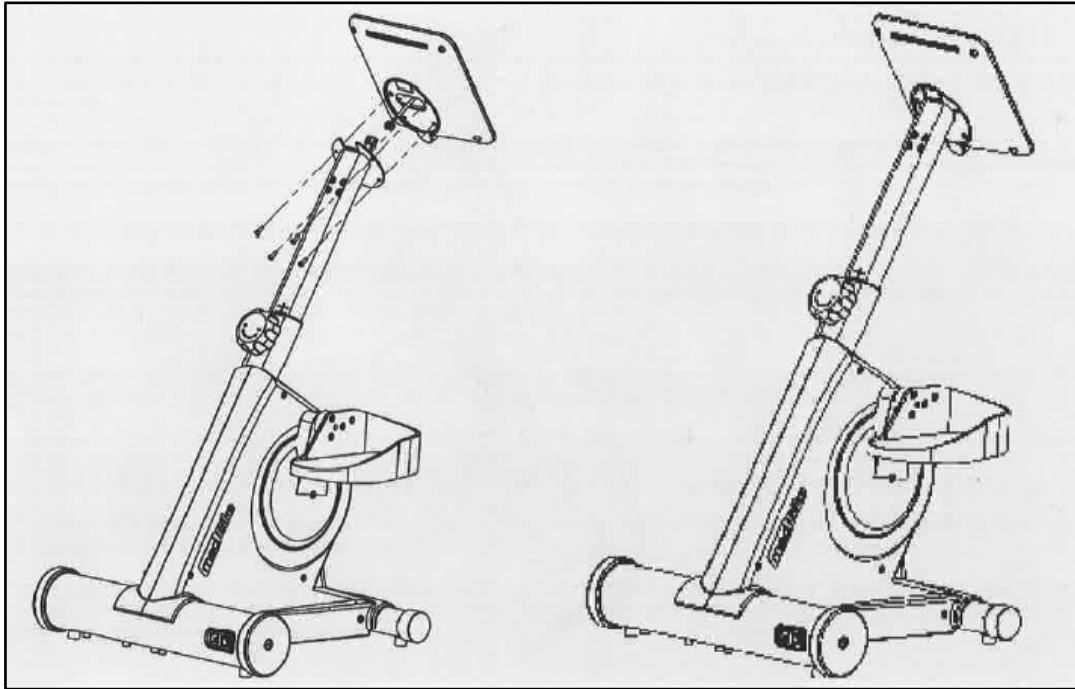

Figure 3.6. Connect the display.

The last step is to affix the handlebars to the handlebars stem tube. Line up the holes for the four bolts and tighten with the Allen wrench.

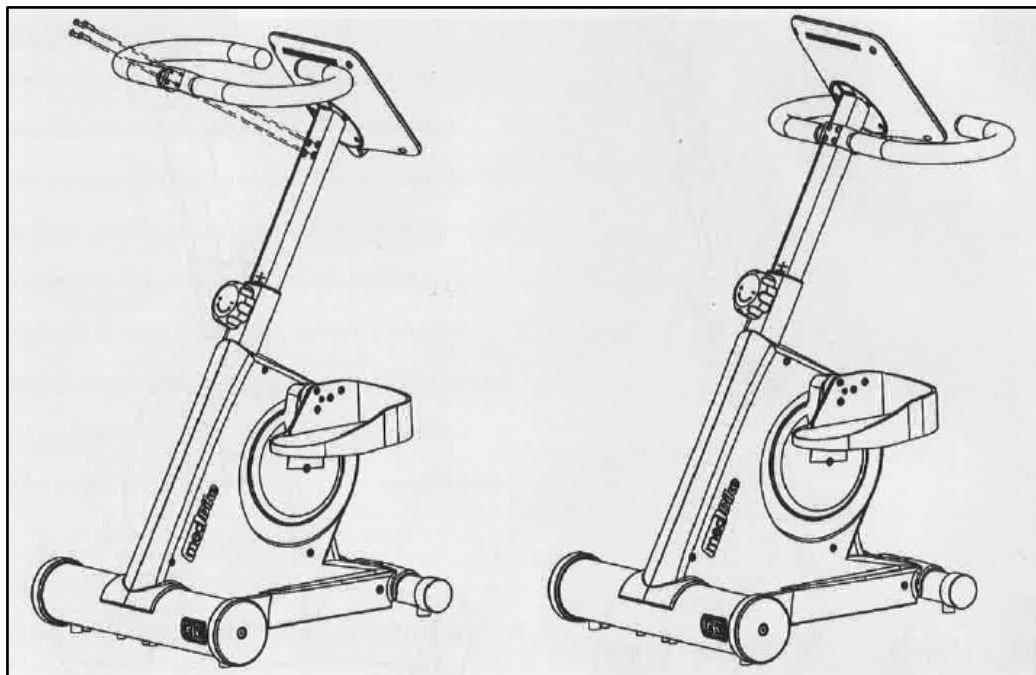

Figure 3.7. Connect the handlebars.

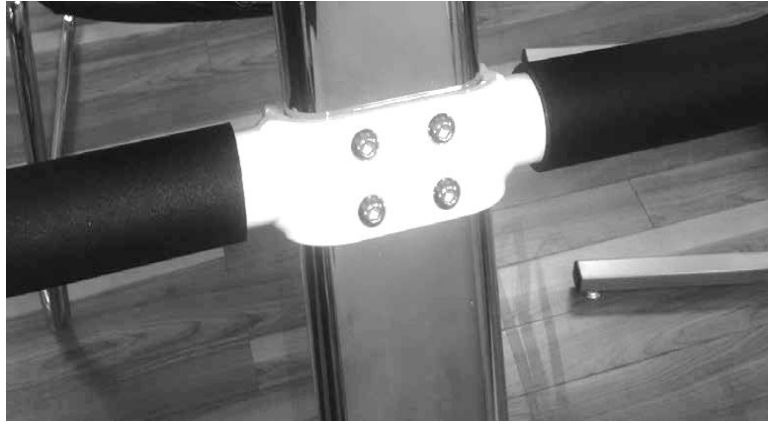

Figure 3.8. Bolts (4) for handlebars.

Adjusting Pedals on the medBike

Managing the degree of hip flexion for certain patients using this device could be a concern. First, consider moving their seat back a few inches. If the seat back reclines, consider that option as well. The pedal crank radius is easily changed. Using the Allen wrench, remove pedal crank bolt and move it into a closer hole on the crank as illustrated in Figure 3.9 reducing the radius of the pedal crank:



Figure 3.9. Adjusting the Pedal/Arm Cranks using an Allen Wrench

Or, using the slim wrench included with the medBike, move the pedal to another hole on the crank by inserting the wrench between the pedal and the crank as illustrated in the diagrams below and unscrewing the pedal crank:



Figure 3.10. Adjusting the Pedal Cranks Using the Included Slim Wrench

This method avoids damaging the inner thread of the Allen bolt.

Positioning or Relocating the medBike



CAUTION: Before moving the medBike, make sure the power cord is detached. If left attached, the cord plug will rub against the floor as the device is being moved possibly causing black marks on the flooring.

The medBike can be moved across smooth surfaces. To move the medBike, remove the power cord from the base of the device. Stand behind the device and lift the back end up, pivoting it forward until the front wheels make contact with the floor. Push or pull the device to a new location and set it down gently.

Display and Handlebars Height Adjustment

The height of the monitor display and handlebars is conveniently adjusted with the hand-turned knob on the front of the device.

To raise or lower the display and handlebars, loosen the knob, pull up or down on the handlebars, and re-tighten the knob.

Positioning for Upper Body Exercise

Loosen Adjustment knob (see Figure 3.11) to and rotate medBike upper body into desired position. Retighten when in place.



Figure 3.11 Positioning medBike for Upper Body Exercise

On / Off

To turn the device on, press the black switch on the base.



Figure 3.12. The ON / OFF switch.

Settings

If the device is not already set to the preferred language, make a selection on the bottom of the screen (EN = English) and touch <Setting>.

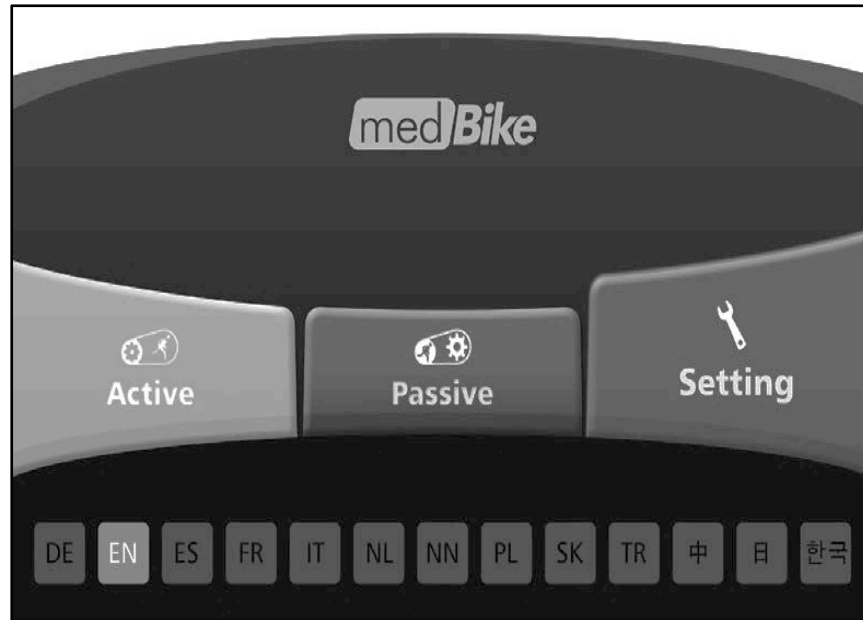

Figure 3.13. Home screen.

Select either the <Metric> or <Imperial> setting for the preferred units of measure. Select the maximum number of rotations per minute (rpm) for the Passive Mode. A rotation is the singular event of moving the pedal/arm cranks all the way around a circular motion.

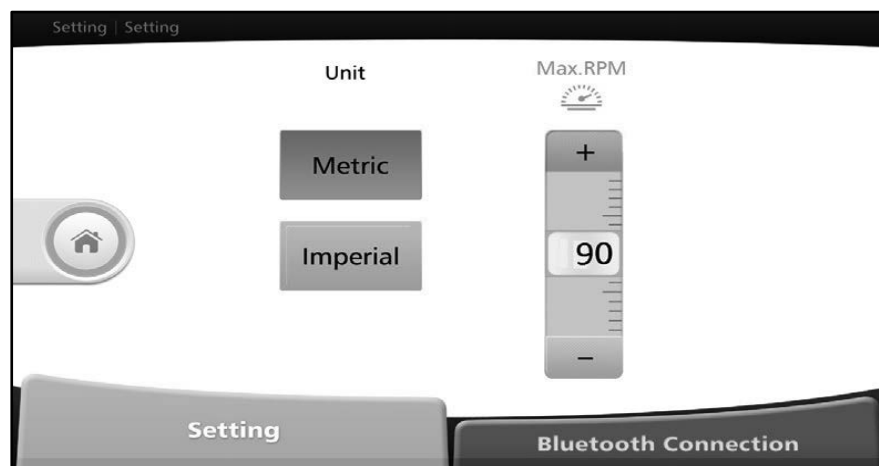

Figure 3.14. Settings screen.

NOTE: Although there is a Bluetooth Connection tab on the Settings screen, this feature is not covered in this document.

Changing Pedal/Arm Cranking Directions While Exercising

The user or clinician may elect at any time during a session to change the pedal/arm cranking direction from forward to reverse or reverse to forward. It is important to stop pedal/arm crank movement completely for a few moments while the device mechanisms reset.



CAUTION: Stop pedal/arm cranking when switching between forward to reverse, and vice versa.

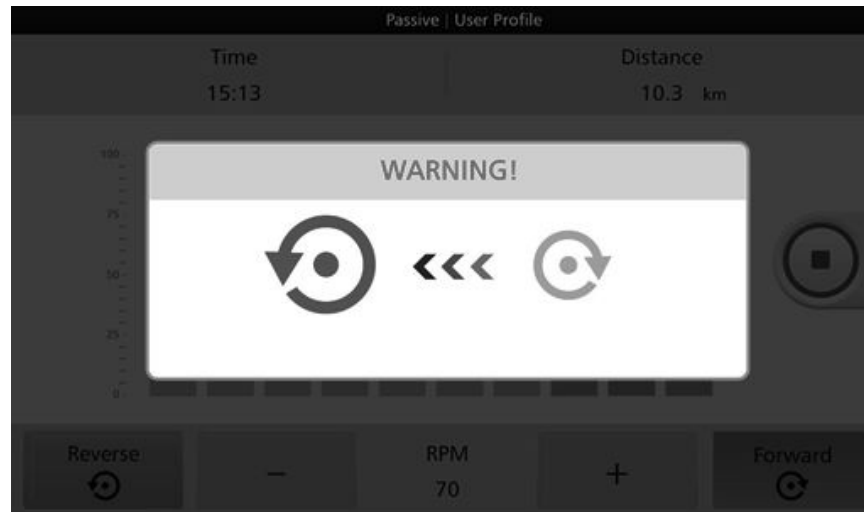

Figure 3.15. Warning screen — Stop pedal/arm cranking completely for a moment before reversing direction.

After the warning screen and countdown disappears, press the <Green Arrow> to resume the exercise in the new pedal/arm cranking direction, or press the <Red Square> to end the exercise.

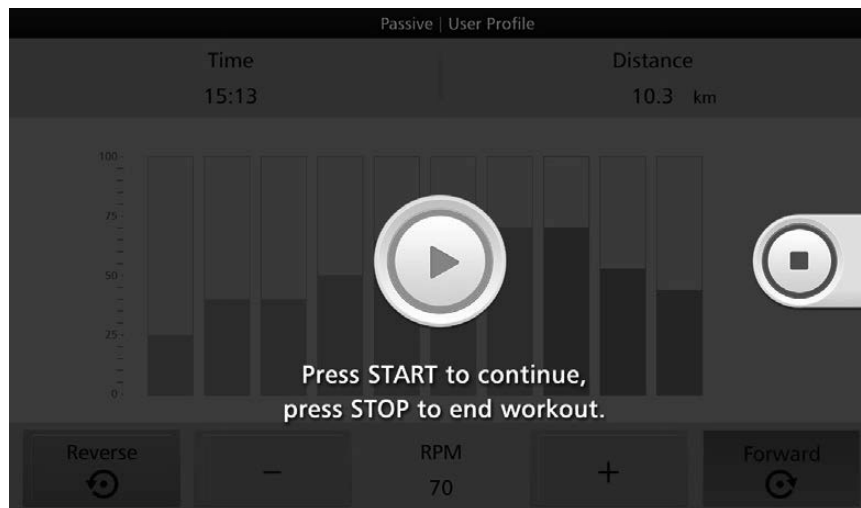

Figure 3.16. START/STOP screen.

Spasm Control

For user safety, the medBike is equipped with a Spasm Control sensor. medBike spasm control detects sudden twitching and/or rapid pedal/arm crank movement in opposite directions. If this

occurs, pedal/arm crank movement will gently cease and the screen will display an Overload! message. A therapist is able to intervene and decide what action to take.

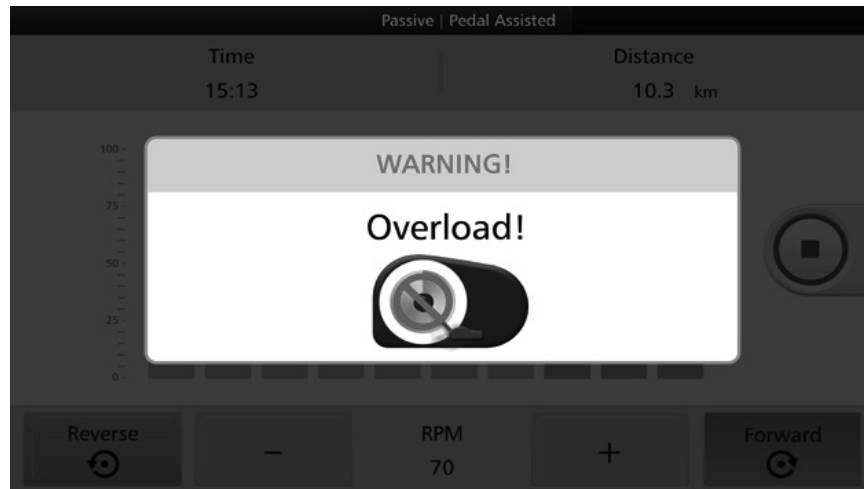

Figure 3.17. Spasm control warning screen.

NOTE: If pedal/arm crank rotation is completely resisted in the Passive Mode for a period of time (about a minute), a “Motor over current protection” message may be displayed. To protect the motor mechanism, the device will suspend operations. When this event occurs, turn the device off with the ON / OFF switch at the base and turn the power back on.

Emergency Stop

The medBike is equipped with an <EMERGENCY STOP>. If, for any reason, a user wants to quickly pause or discontinue an exercise session — be it in Active or Passive mode — it can be accomplished by pressing <STOP>. To continue exercising, <STOP> must be pressed a second time. There is an option to resume the session or finish the session and starting a new one.



Figure 3.18. Location of Emergency Stop button.



Figure 3.19. Emergency Stop warning screen.

4. Active Modes

Active Manual Mode

In the Active Manual mode, the user of the device is moving the pedal/arm cranks at a constant rate of resistance throughout the exercise. From the Home screen, touch <Active>.

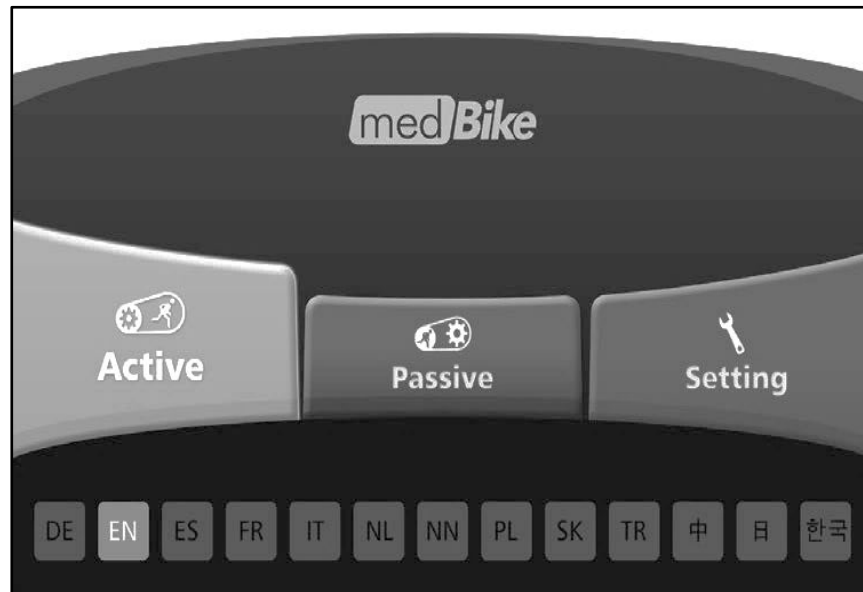

Figure 4.1. Home screen.

Select <Manual> and set the exercise parameters. When the Upper Body is present, the option to select Upper or Lower Body is displayed. Select the desired exercise and set the total exercise time followed by user weight. When finished, press the <Green Arrow>.

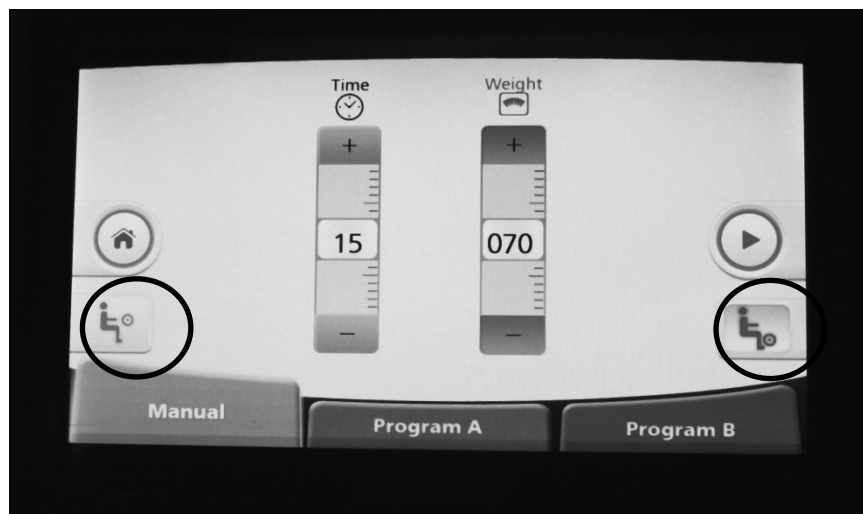

Figure 4.2. Active Manual Settings.

Press <+> or <-> to adjust the resistance level for the Forward and/or Reverse directions. The resistance level can be increased or decreased throughout the exercise session, and the pedal/arm cranking direction can be changed as well. As the user completes each segment, the column representing that segment will turn grey.



Figure 4.3. Active Manual Settings—resistance levels.

If the <Red Square> is pressed to stop the exercise, the results data from the workout is displayed.

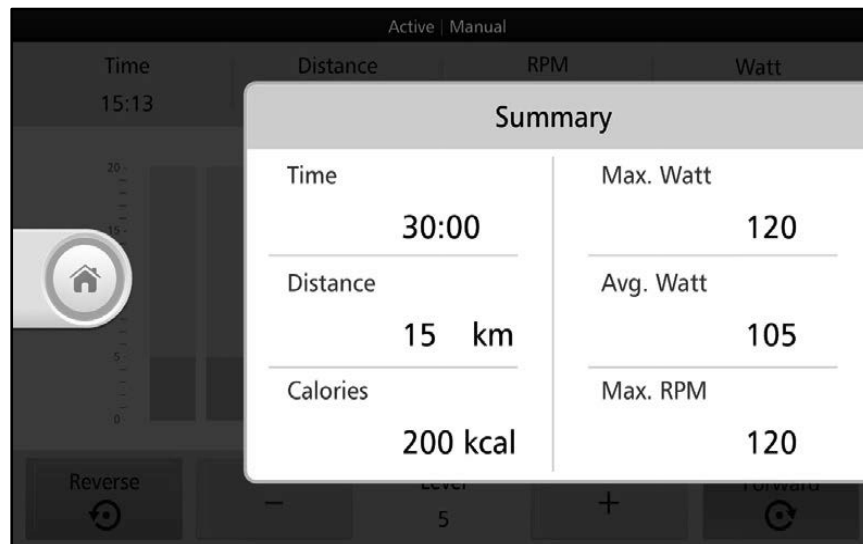

Figure 4.4. Active Manual Mode Results.

Press <Home> to return to the Home screen.

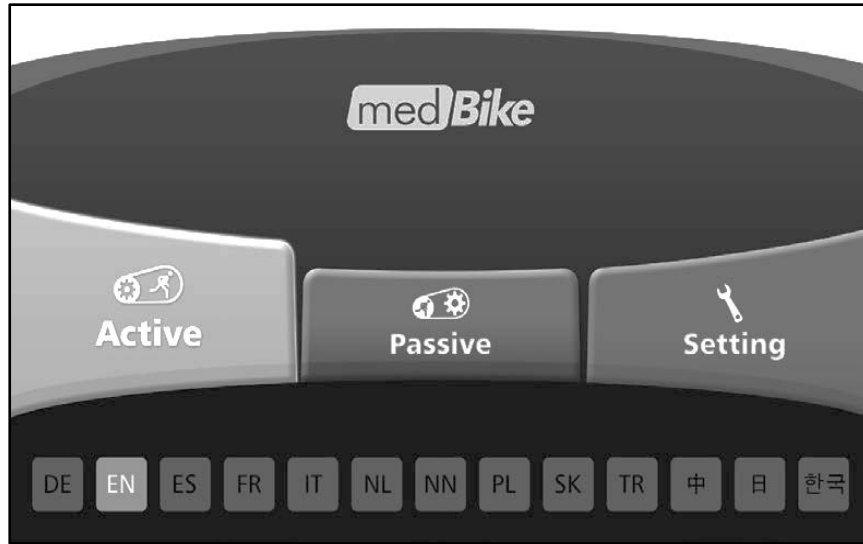

Figure 4.5. Home screen.

Active Resistance Mode (Program A)

In the Active Program A mode, the user is moving the pedal/arm cranks at a constant rate during each configured segment of a session. Select <Program A>.

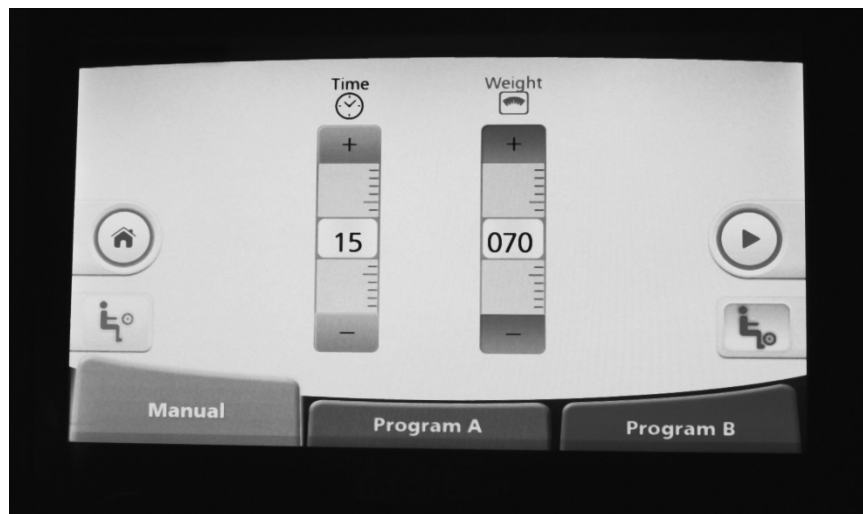

Figure 4.6. Active Resistance Mode (Program A—exercise time and patient weight settings).

Select Upper or Lower Body. Set total exercise time and enter the user's weight. Press NEXT.

On the Resistance Levels screen, set the resistance for each segment by touching a higher or lower portion of the segment to ramp up or ramp down that segment. Touch the orange <+> /-<-> buttons to adjust the resistance for a particular segment as well as the pedal/arm cranking direction. (The segments in Figure 4.7 illustrate the pedal/arm cranking in the forward direction.) Press the <Green Arrow>.

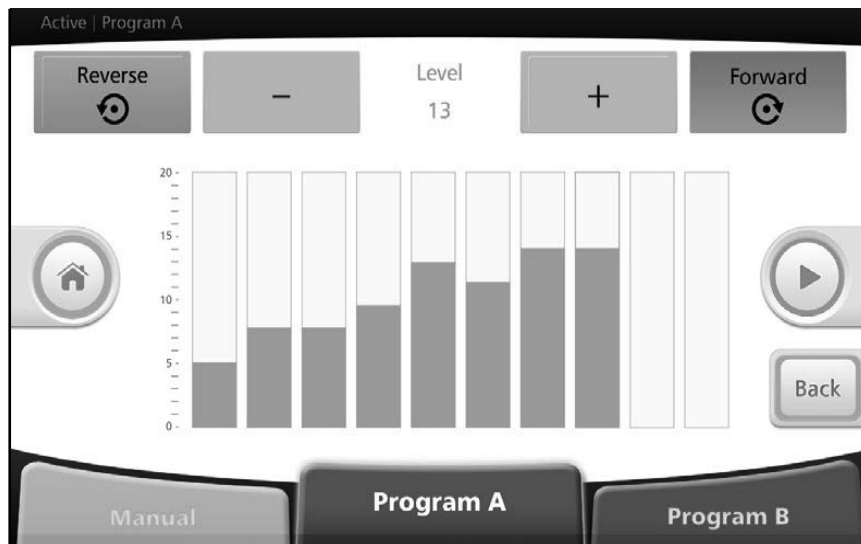

Figure 4.7. Active Resistance Mode (Program A)—resistance level setting screen.

During the session, press the orange <+> /-<> buttons to adjust the resistance level for each segment. Alternatively, touch a higher or lower portion of the active segment (the one that has a green or blue trim all the way around) to ramp up or ramp down that segment.

The pedal/arm cranking direction can be changed by pressing <Reverse> or <Forward>.



Figure 4.8. Active Resistance Mode (Program A)—resistance level setting screen (individual segments).

If the <Red Square> is pressed to stop the exercise, the results data from the workout is displayed.

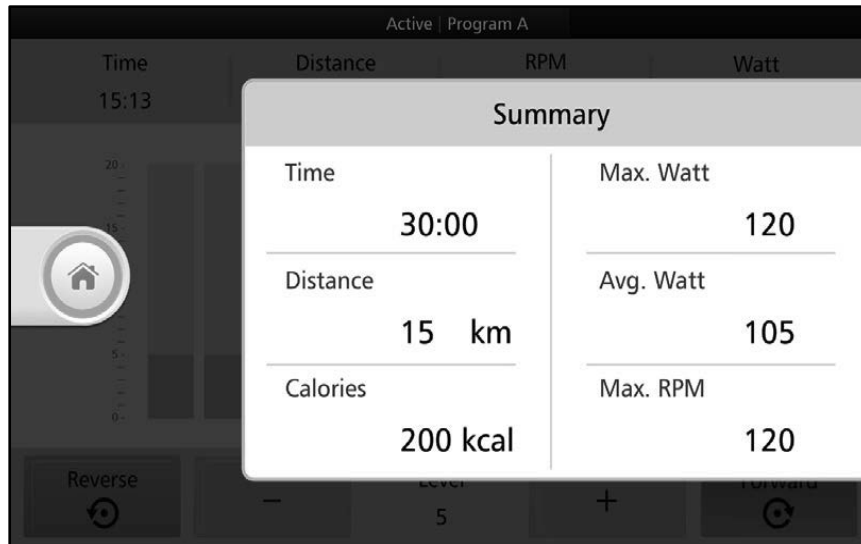

Figure 4.9. Active Resistance Mode (Program A) Results.

Press <Home> to return to the Home screen.

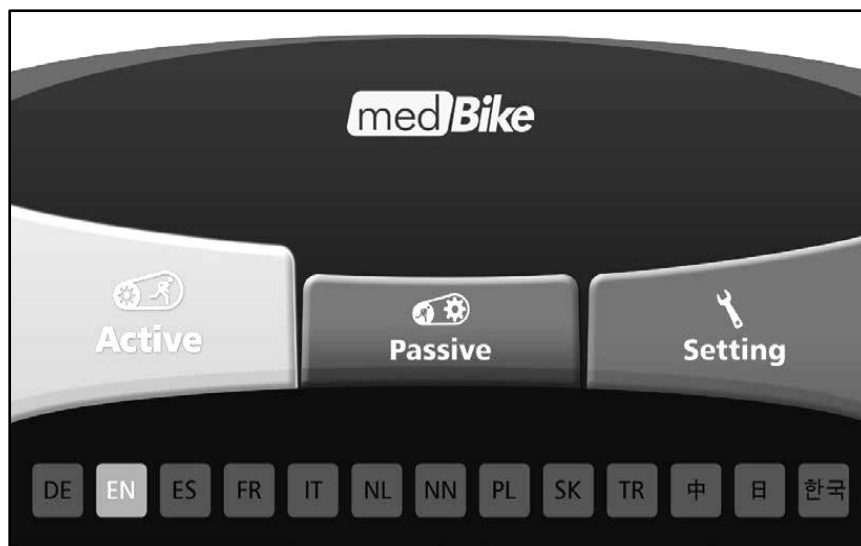

Figure 4.10. Home screen.

Continuous Watt Mode (Program B)

In Active Program B mode, the level of Watts generated by the user's pedal/arm cranking is fixed instead of the resistance level as with the Manual and Program A modes. Because Watts are a function of rpms and resistance level, the two factors will adjust depending on the user's performance. Therefore, if the user is pedal/arm cranking quickly and generating a high number of rpms, the resistance level will drop. If the user is producing a small number of rpms, the resistance level will raise proportionately to maintain the designated Watt output.

To start a continuous Watt session, click <Program B>.

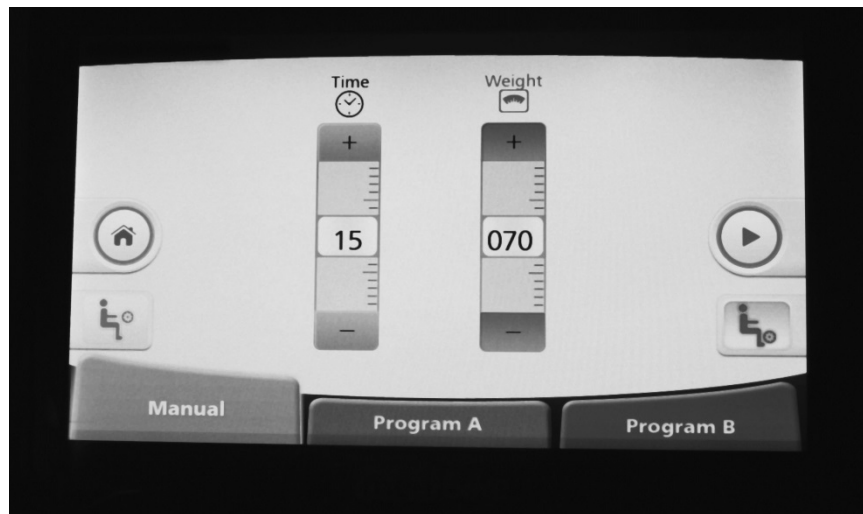

Figure 4.11. Continuous Watt Mode (Program B—exercise time and patient weight settings).

Select Upper or Lower Body. Set total exercise time and enter user weight. Press <NEXT>. On the next screen, set the Watt level for each segment. Press the <Green Arrow>. During the exercise session, the medBike will adjust resistance levels automatically to maintain the programmed Watt zone.

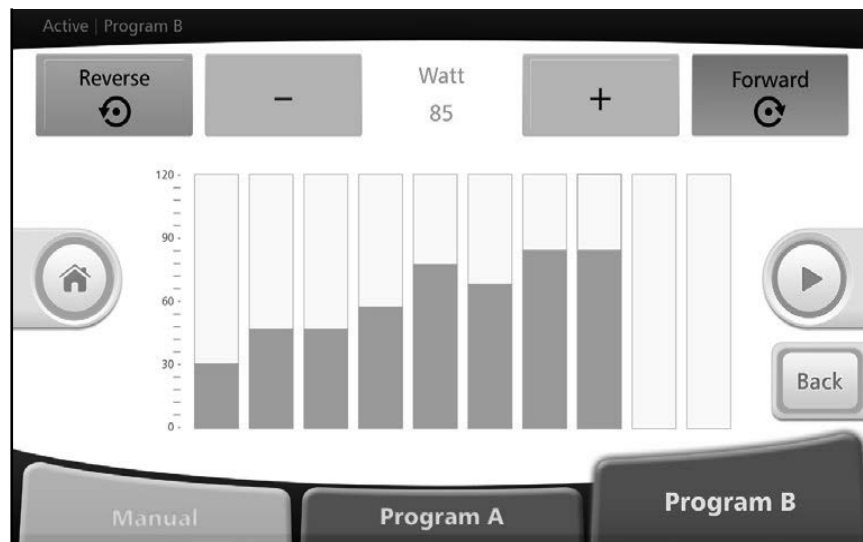

Figure 4.12. Continuous Watt Mode (Program B)—Watt level setting screen (individual segments).

Press <+> or <-> to adjust Watt level during the exercise session. The Watt level can remain constant, as illustrated below or change from segment-to-segment.

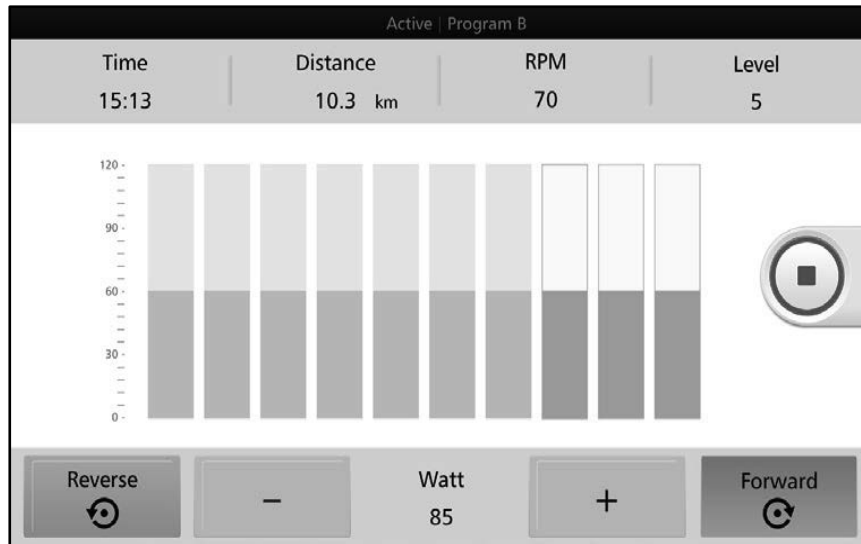

Figure 4.13. Continuous Watt Mode (Program B)—in-session screen.

If the <Red Square> is pressed to stop the exercise, the results data from the workout is displayed.

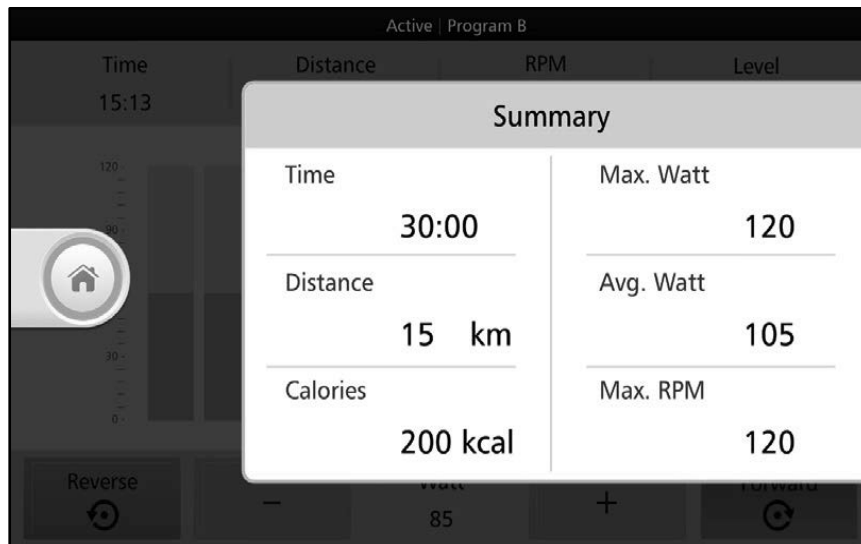

Figure 4.14. Continuous Watt Mode (Program B) Results.

Press <Home> to return to the Home screen.



Figure 4.15. Home screen.

5. Passive Modes

Passive Manual Mode

The Passive Manual mode is used when the user has moderate to severe lower extremity limitations and must rely on the device's motor to rotate the pedal/arm cranks. The rpm level is set prior to the start of the session and can be adjusted as needed during the exercising.

To start a Passive Manual session, press <Passive>.

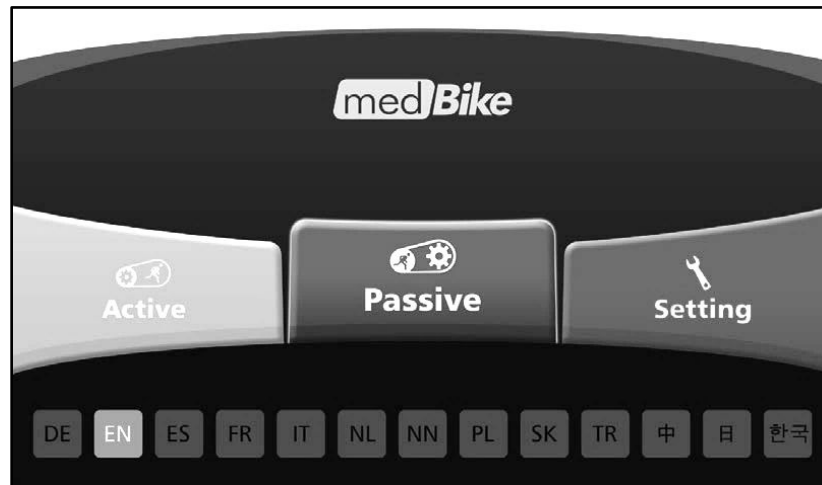

Figure 5.1. Home screen—select passive mode.

Set total exercise time, rotations per minute (rpm), and enter the user's weight.

Bodyweight is used for two reasons; 1) to estimate limb size for the spastic detection (overload) algorithm, and 2) to estimate, using a standard formula, the number of calories burned during the exercise session.

Note: Calorie burn rate will probably not be significant, as the user is seated and the device is assisting with limb movements.

Press the <Green Arrow> to begin exercising.



Figure 5.2. Passive Manual Mode—settings screen.

As the user moves through each segment, the completed segments will turn gray. While the user is exercising, press <+> or <-> to adjust rpm level or <Reverse> or <Forward> to change pedal/arm cranking direction.



Figure 5.3. Passive Manual Mode—rpm level setting screen (individual segments).

If the <Red Square> is pressed to stop the exercise, the results data from the workout is displayed.

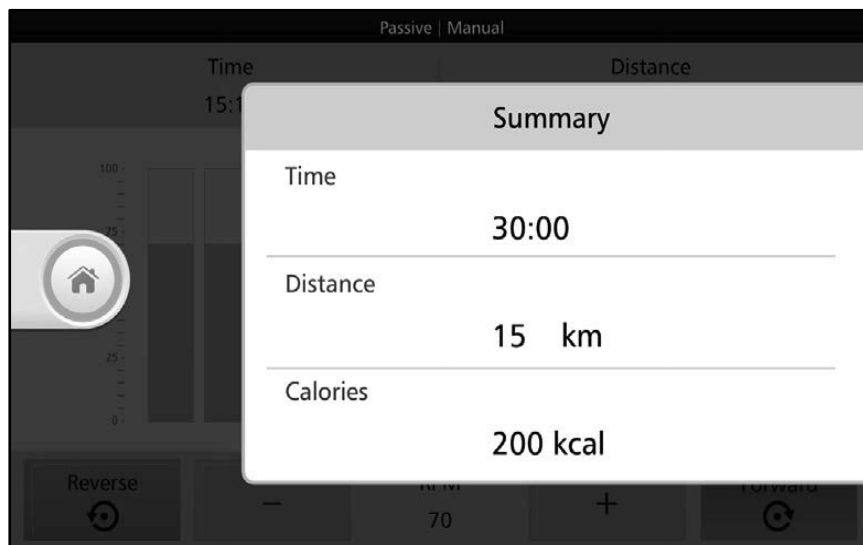

Figure 5.4. Passive Manual Mode Results.

Press <Home> to return to the Home screen.



Figure 5.5. Home screen.

Passive User Profile Mode

The Passive User Profile mode, like the Passive Manual mode, is used when the user has moderate to severe lower extremity limitations must rely on the device's motor to rotate the pedal/arm cranks.

In the User Profile mode, the session can be customized into individual segments where the pedal/arm cranking direction and rpm levels can be set per segment. The rpm level and pedal/arm cranking direction can also be adjusted as needed while a particular segment is active.

To start a Passive User Profile session, press <User Profile> from the Passive Modes menu.



Figure 5.6. Passive User Profile Mode— settings screen.

Select Upper or Lower Body. Set total exercise time and enter user weight and press <Next> to begin customizing individual segments within the session.

Touch any individual segment (rectangular boxes in the middle of the screen) to set the rpm and pedal/arm cranking direction for that particular segment.

Press the <Green Arrow> to begin exercising.

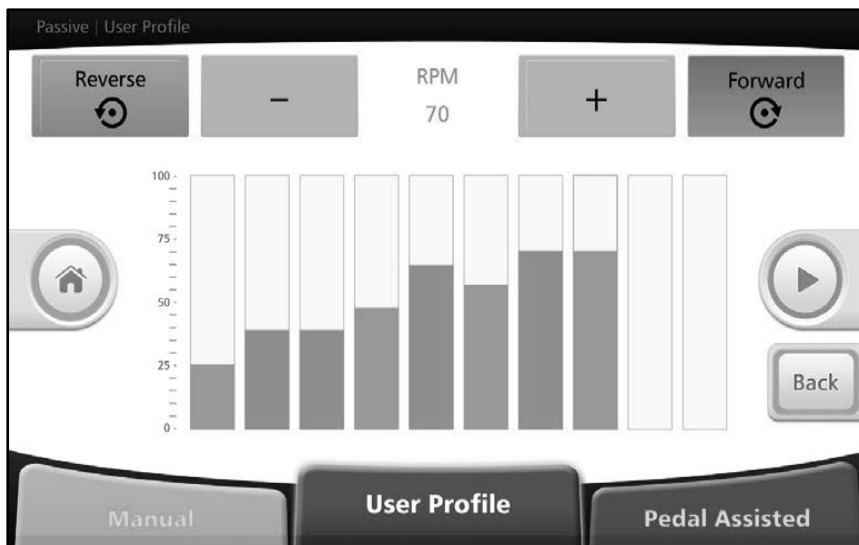

Figure 5.7. Passive User Profile Mode—rpm levels and pedal/arm cranking direction settings screen (individual segments).

As the user moves through each segment, the completed segments will turn gray.



Figure 5.8. Passive User Profile Mode—in-progress exercise screen.

If the <Red Square> is pressed to stop the exercise, the results data from the workout is displayed.

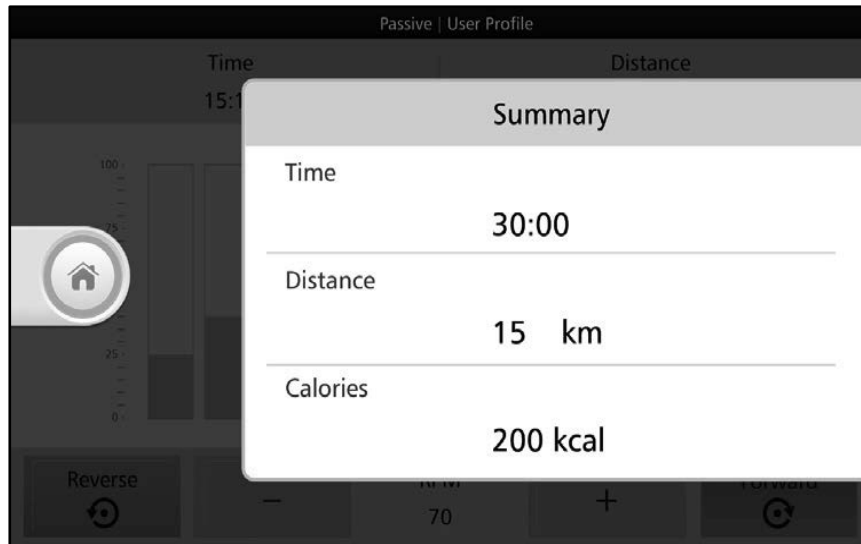

Figure 5.9. Passive Manual Mode Results.

Press <Home> to return to the Home screen.

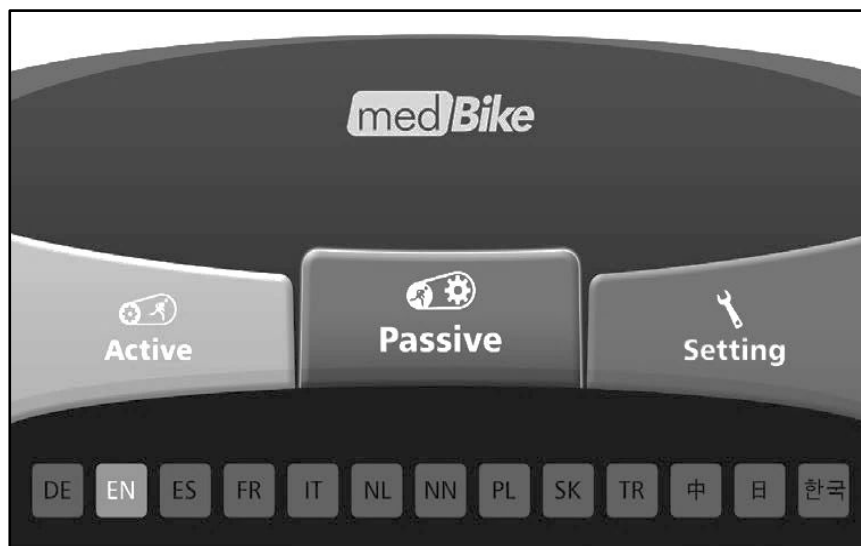

Figure 5.10. Home screen.

Passive Pedal/Arm Crank Assisted Mode

Pedal/Arm Crank Assisted mode is different from the other two passive modes. The Pedal/Arm Crank Assisted mode is designed for users who have some lower extremity capacity, but still have too many strength and endurance deficits to use one of the active modes.

The sensors in the medBike will recognize when the user is no longer able to move the pedal/arm cranks without help. The passive mode mechanism will activate to maintain a constant rpm level.

To start a Pedal/Arm Crank Assisted session, select <Pedal/Arm Crank Assisted> from the passive modes menu.



Figure 5.11. Passive Pedal/Arm Crank Assisted Mode— settings screen.

Set total exercise time and enter user weight and press the <Next> button.

Set desired rpm and pedal/arm cranking direction for each segment. Press the <Green Arrow>.

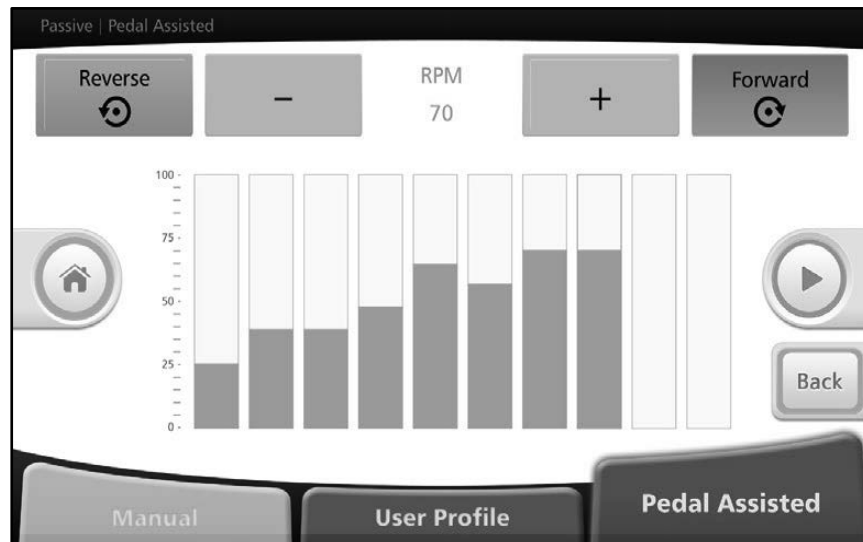

Figure 5.12. Passive Pedal/Arm Crank Assisted Mode— rpm settings screen (individual segments).

Start pedal/arm cranking. After 30 seconds, the warmed-up medBike will start sensing and compare actual rpm to set rpm.

In case the actual rpm is 15% (or more) lower than set rpm, medBike will assist user to reach the set rpm. The sensing frequency is modulated in accordance with EXERCISE TIME and SET RPM.

Press <+> or <-> to adjust rpm.

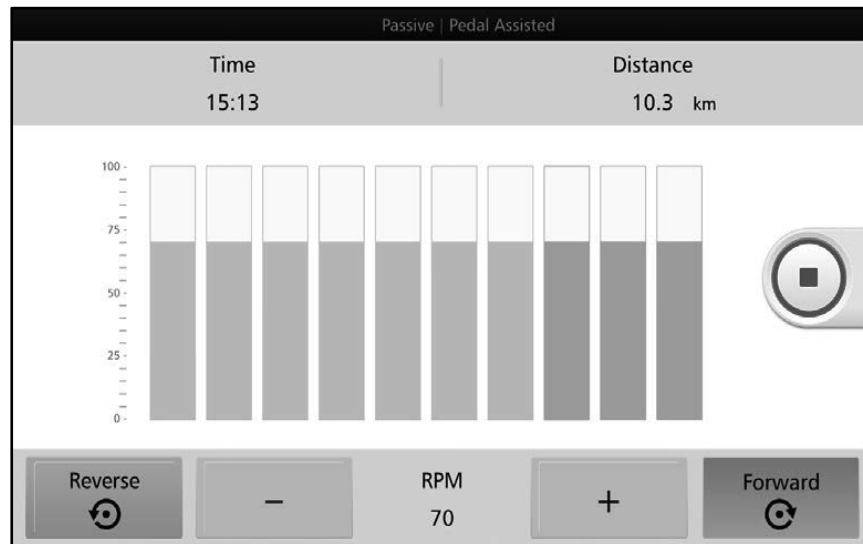

Figure 5.13. Passive Pedal/Arm Crank Assisted Mode—in-progress exercise screen.

If the <Red Square> is pressed to stop the exercise, the results data from the workout is displayed.

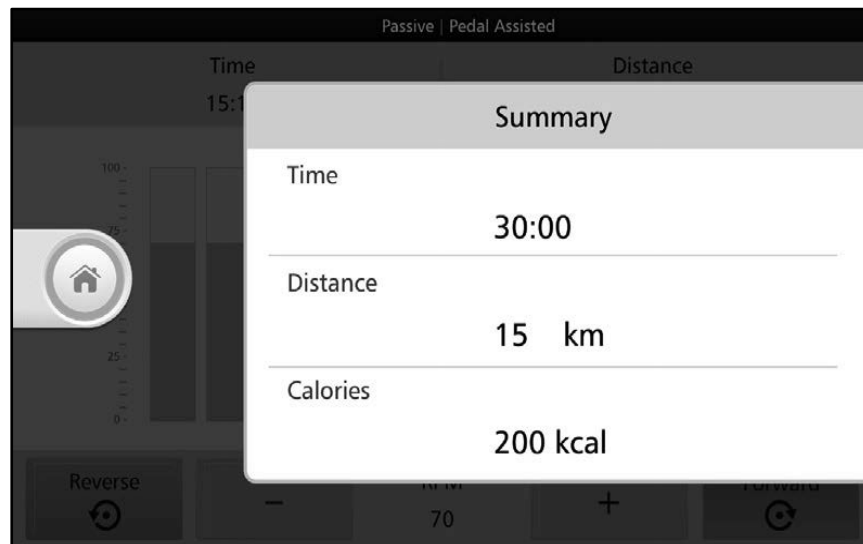

Figure 5.14. Passive Manual Mode Results.

Press <Home> to return to the Home screen.



Figure 5.15. Home screen.

6. Specifications

Dimensions:

Lower Body Cycle only: 25" l x 20.6" w x 39.6" h (64 x 52 x 101 cm)

Weight: 75 lb (34 kg)

Whole Body Cycle: 26 1/2" l x 21 3/4" w x 48"h (67x 55 x 122 cm)

Weight: 104 lb (47 kg)

Height Adjustable: Telescoping handlebar post: Range 4" (10 cm)

Display: 10" (25.4 cm) TFT touchscreen

Hand Grips: Non-allergic, high density; telescopic handlebar post

Pedal cranks: Fully articulating with heel cup and safety straps

Finish: Full metal frame, enamel powder, electrostatic

Wheels: Durable transport

Speed Control: 10-90 rpm in passive mode

Work Rate Range: 1-120 Watts (100 Watts at 90 rpm in Active mode)

Warranty: Two year parts; one year labor.

Assembly drawings and parts list are available from Biodex customer service.

Calf Support Assembly

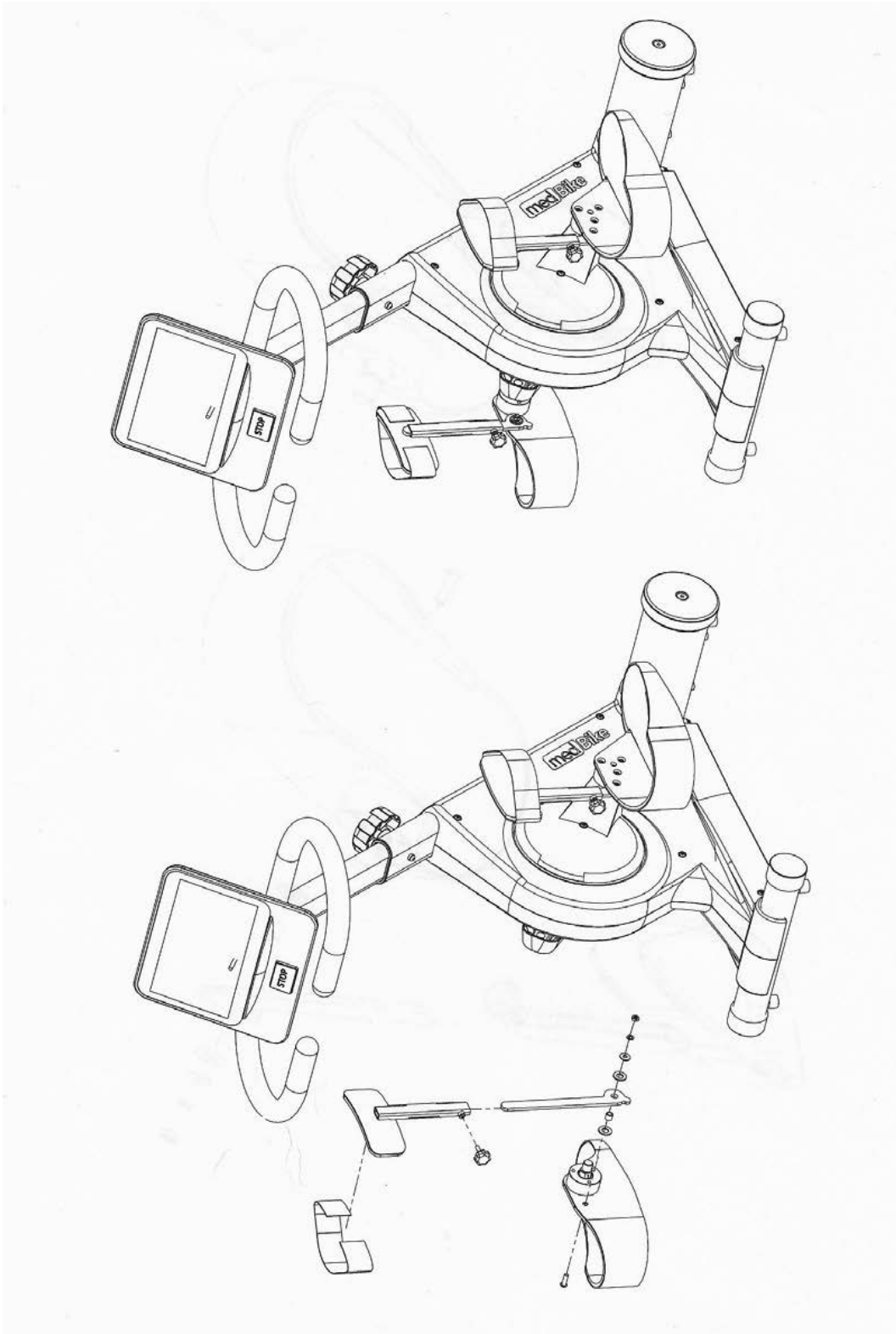

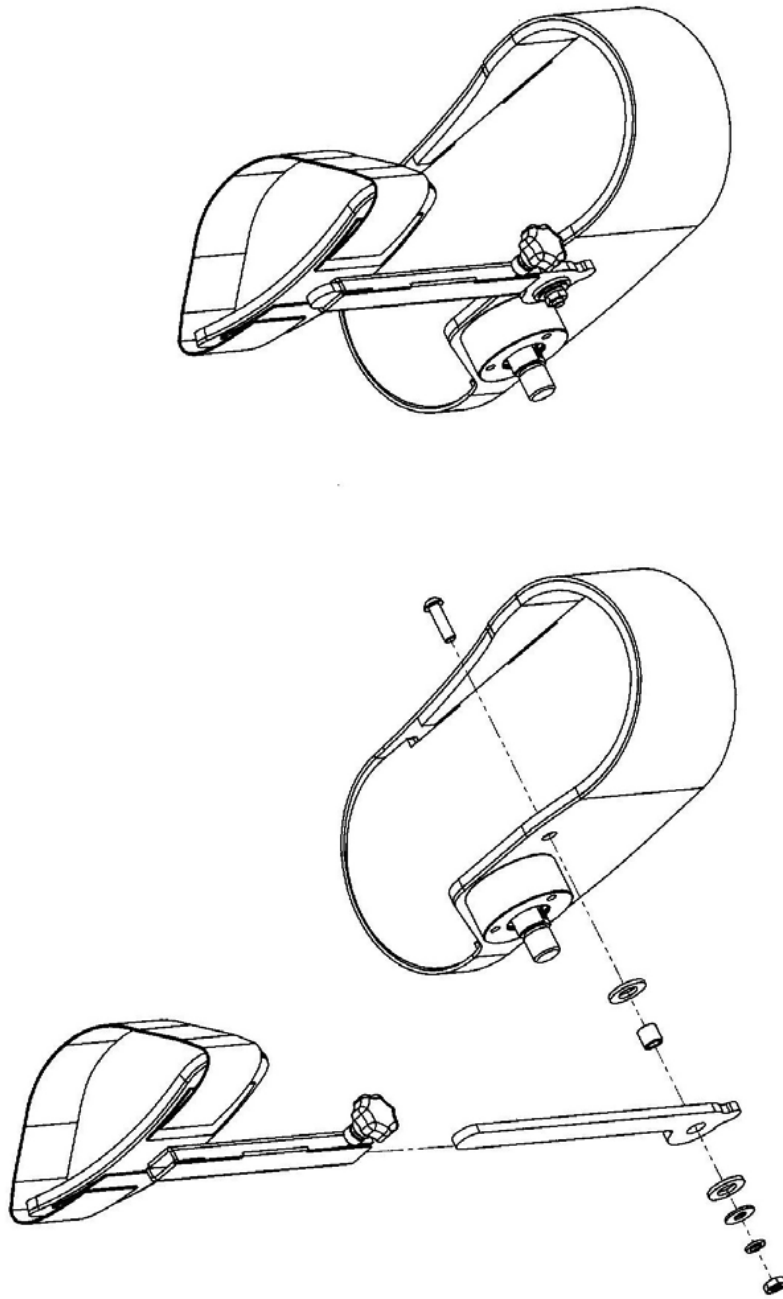

BIODEX

Biodex Medical Systems, Inc.

20 Ramsey Road, Shirley, New York, 11967-4704, Tel: 800-224-6339 (*intl 631-924-9000*), Fax: 631-924-9338, Email: info@biodex.com, www.biodex.com